

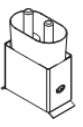

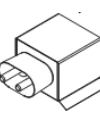
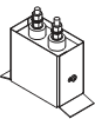
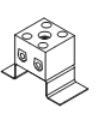

KUPAC:	Vaš znak:	
ADRESA:	Telefon:	E - mail:
OSOBA ZA KONTAKT:	Telefon:	Mob.:
		E - mail:

PODACI O GREJAČU:	Snaga (W):	Radni napon (V):	Otpor grejača (Ω):	
KOLIČINA (kom):	Prečnik grejača Φ (mm):	Širina grejača (mm):	Dužina priključka (mm):	Presek priključka (mm ²):

Priključak <i>Izaberite zaokruživanjem priključak (br.)</i>							
	AXIAL	RADIAL	TANGENTNI				
Broj:	1	2	3	4	5	6	7

Položaj otvora i priključka na grejaču

Otvor:	α (°)	A (mm)	Φ (mm)
1			
2			
3			
4			
5			
6			
Priključak:			

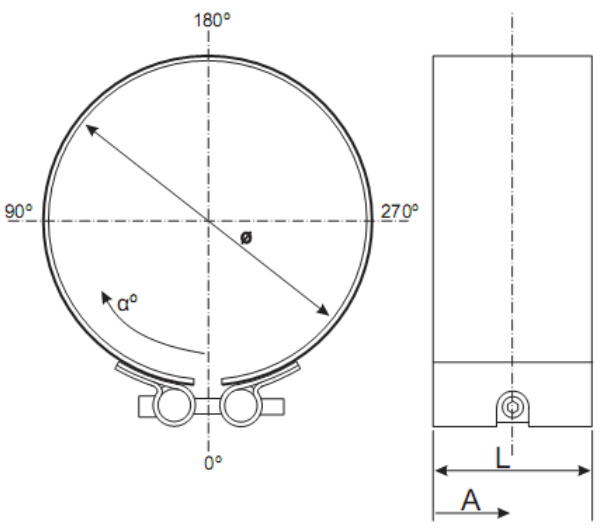

<p>NAPOMENE:</p> <p>NAPOMENA PROIZVOĐAČA: Molimo navedite sve specifične zahteve za primenu našeg proizvoda što će opredeliti izbor materijala i konstrukciono rešenje (Radna temperatura na plaštu grejača, radna temperatura medijuma - elementa koji se greje, temperatura kojoj su izloženi priključni krajevi, mehanički priključak grejača, ...)</p>	<p>Prilozi:</p> <p>Veza:</p>
-----------------------------------------------------------------------------------------------------------------------------------------------------------------------------------------------------------------------------------------------------------------------------------------------------------------------------------------------------------------------------------------------------------------	-----------------------------------------------------------------------------------

Način isporuke:	
Datum:	Potpis pošiljaoca: